



11' x 9' Insta-Clip Screen House

Instructions apply to Part Number 9392-119

ASSEMBLY PARTS

When You Are Ready To Set Up Your Shelter

- Select a level area clear of rocks, branches and other hard or sharp objects.
- Do not set up your shelter under trees.
- For easier set up, two or more people are recommended.
- Place fabric in center of selected location and assemble above fabric.

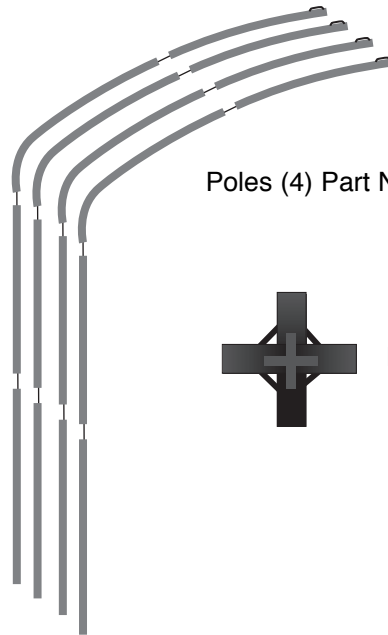

Poles (4) Part No. 9392-1081



Hub (1) Part No. 9392-1071

1 Pole Assembly

- You will need to assemble and connect one pole at a time to the hub.
- Do not completely assemble poles.
 - Beginning at spring-clip end of pole, assemble all but the last shock-corded section. The pole and one section should curve downward. (illus. 2)
 - Insert the spring-clip end into one of the hub ports until it clicks into position. (illus. 1), (illus. 2)
 - Repeat for each of the three remaining poles (illus. 2)

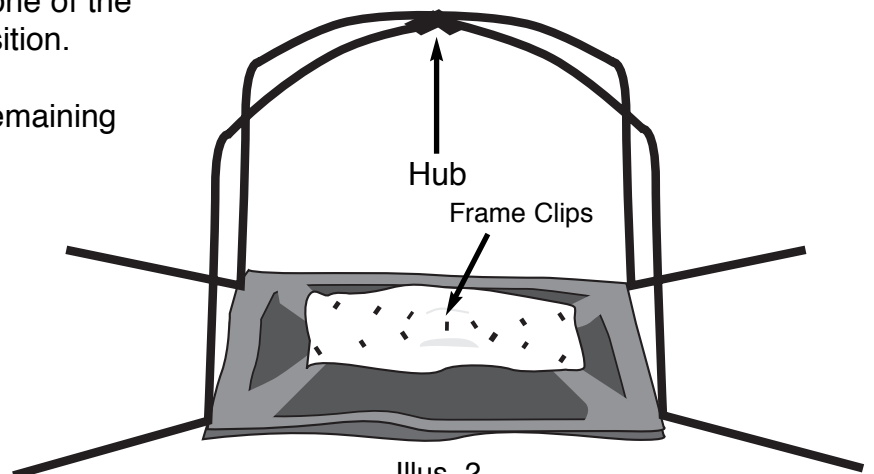
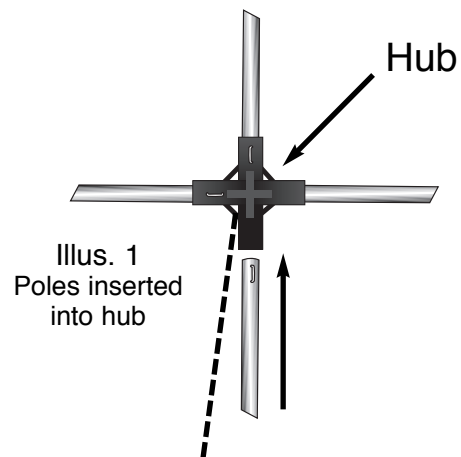

Illus. 2
Screen House laid out in position with partially assembled frame locked into hub.

2 Attach Shelter to Frame

- With the frame still partially set up, clip the center of the Screen House to the center hub. (illus. 3)
- Starting towards the center of the Screen House, clip the shelter fabric to the poles.

Start by attaching the center of the Screen House to the pole hub.

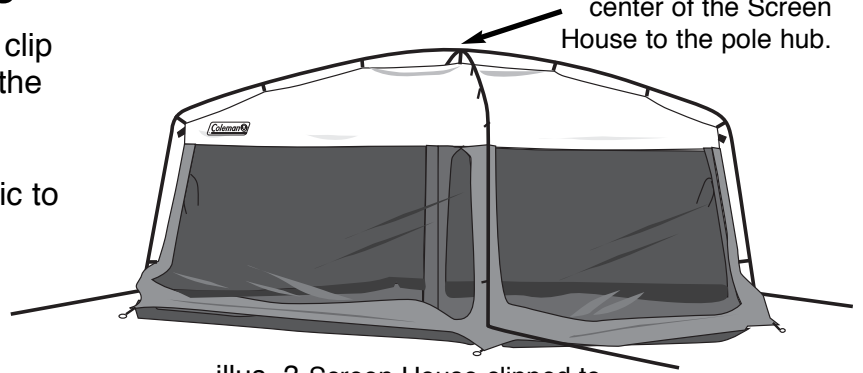

illus. 3 Screen House clipped to partially assembled frame

3 Complete Shelter

- Fully extend each pole by straightening all shock-corded pole sections.
- Insert the pin on the pin and ring system, at the corner of the Screen House into the pole end. (illus. 4), (illus. 6)
- Repeat for remaining poles.
- Adjust poles to pull the shelter taut and stake down through the fabric loops at the end of pin and ring. (illus. 5), (illus. 6)
- Attach guy lines to fabric guy loops at each corner and stake out (illus. 6)

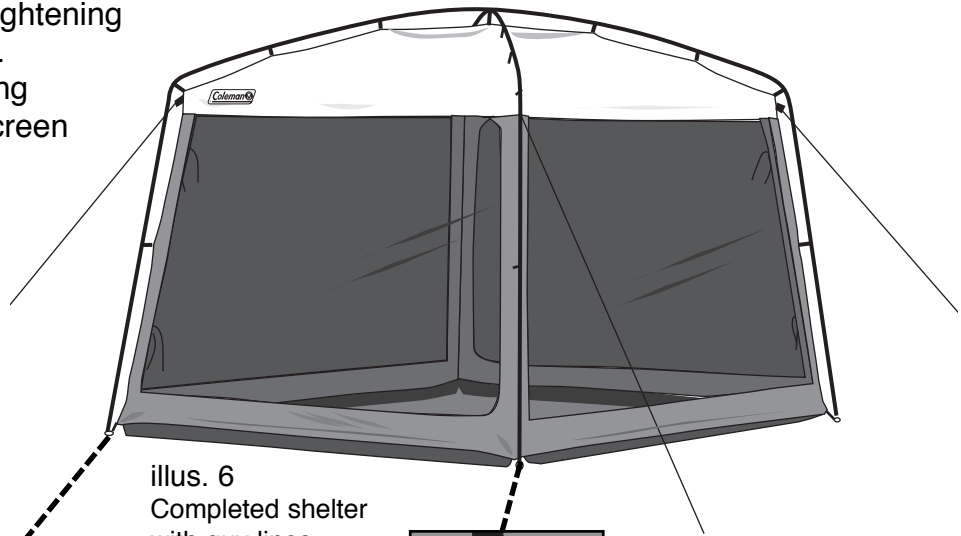

illus. 6 Completed shelter with guy lines staked out

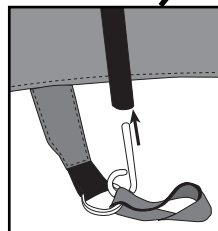

illus. 4
Insert into the pole end

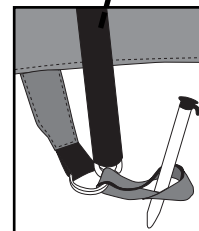

illus. 5
Stake through stake loop

Things You Should Know

- Never store shelter, even for a short period of time, without drying it thoroughly and brushing off caked dirt. Do not pack stakes or poles inside your shelter. Use separate storage bag.
- STAKES SHOULD BE REMOVED BY PULLING ON THE STAKE ITSELF. NEVER PULL ON THE SHELTER FABRIC OR STAKE LOOP TO REMOVE STAKE.
- SHELTER POLES SHOULD NOT BE LEFT TELESCOPED TOGETHER DURING STORAGE.
- Do not leave your shelter set-up for weeks at a time, be aware that exposure to the ultraviolet rays of the sun can seriously damage material and/or cause it to become discolored.

WARNING: Keep all flame and heat sources away from this shelter fabric. This shelter meets the flammability requirements of CPAI-84. The fabric will burn if left in continuous contact with any flame source. The application of any foreign substance to the shelter fabric may render the flame-resistant properties ineffective.



THE COLEMAN CO., INC.

3600 N. Hydraulic • Wichita, Kansas 67219
1-800-835-3278 • www.coleman.com

MADE IN CHINA

PRINTED IN CHINA Rev. 11/04